

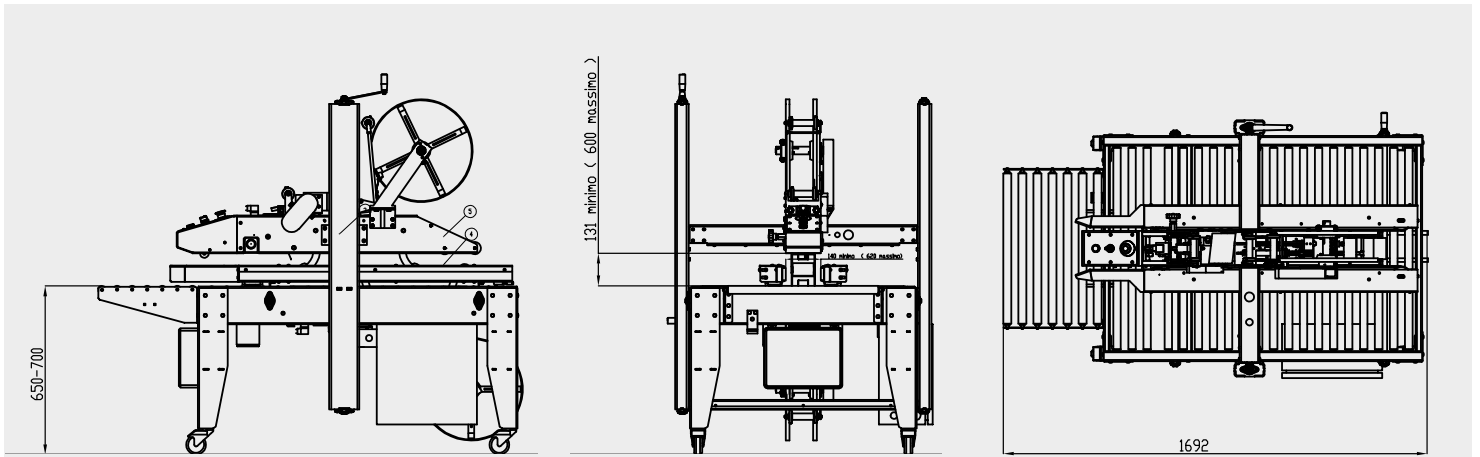

- NASTRATRICE SEMI-AUTOMATICA PER CARTA GOMMATA
- SEMI-AUTOMATIC GUMMED PAPER CASE SEALER
- FERMEUSE DEMI-AUTOMATIQUE POUR BANDE GOMMÉE
- KLEBESTREIFENAUFTRAGS-MASCHINE
- PRECINTADORA SEMIAUTOMATICA PARA PAPEL GOMADO



GEM 520-GP  320 Kg

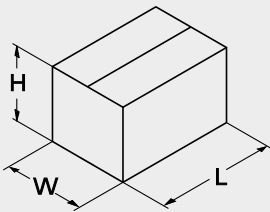

	MIN	MAX
L	150 mm	∞
W	130 mm	600 mm
H	135 mm	600 mm

- Alimentazione pneumatica
- Pneumatic power supply
- Alimentation pneumatique
- Druckluftspeisung
- Alimentación neumática

6 bar

- Consumo aria per ciclo scatola
- Air consumption cycle box
- Consommation d'air par cycle boîtes
- Luftverbrauch pro Kartonzyklus
- Consumo de aire por ciclo caja

0,15 nl

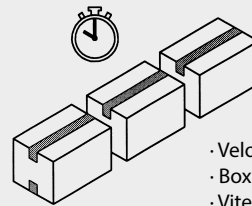

- Produzione media: 720 scatole/ora
- Production moyenne: 720 boîtes/heure
- Producción promedio: 720 cajas/hora
- Average production: 720 boxes/hour
- Durchschnittliche Produktion: 720 Kartons/Std

- Velocità di trasferimento scatola: ~19 mt/min
- Box transfer speed: ~19 mt/min
- Vitesse de transfert de la boîte: ~19 mt/min
- Transportgeschwindigkeit der Kartons: ~19 mt/min
- Velocidad de desplazamiento caja: ~19 mt/min



- Gambe con piedino fisso
- Legs with fixed foot
- Pieds à base fixe
- Standbeine mit fixem Fuß
- Patas con pie fijo

OPTIONAL:

- Gambe con ruote
- Legs with wheels
- Pieds à roulettes
- Standbeine mit Rädern
- Patas con ruedas

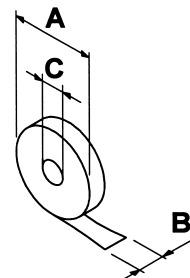
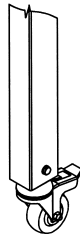

A	MAX 400 mm
B	50 ÷ 80 mm
C	70 mm



- Alimentazione: 230 V 50 Hz
- Power supply: 230 V 50 Hz
- Alimentation: 230 V 50 Hz
- Speisung: 230 V 50 Hz
- Alimentación: 230 V 50 Hz

- Potenza installata: 1 Kw
- Installed power: 1 Kw
- Puissance installée: 1 Kw
- Eingerichtete Leistung: 1 Kw
- Potencia instalada: 1 Kw

- Protezione elettrica: IP54
- Electrical protection: IP54
- Protection électrique: IP54
- Stromschutz: IP54
- Protección eléctrica: IP54

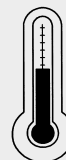

MAX
+40°C/104°F

MIN
+5°C/41°F

- Temperatura di utilizzo:
- Temperature of use:
- Température d'utilisation:
- Betriebstemperatur:
- Temperatura de uso:

Distributed by

 **COMARME**

COMARME S.r.l. a socio unico

sede operativa (factory)
Quartiere Mirabella snc, 20081 Abbiategrasso (MI) - ITALY
Tel. +39 02 9422002 - Fax +39 02 9422096

e-mail: info@comarmesrl.com - website: www.comarmesrl.com